

# PLAN D'IMPLANTATION ODYSSEE18WQP-CV

VUE DE FACE

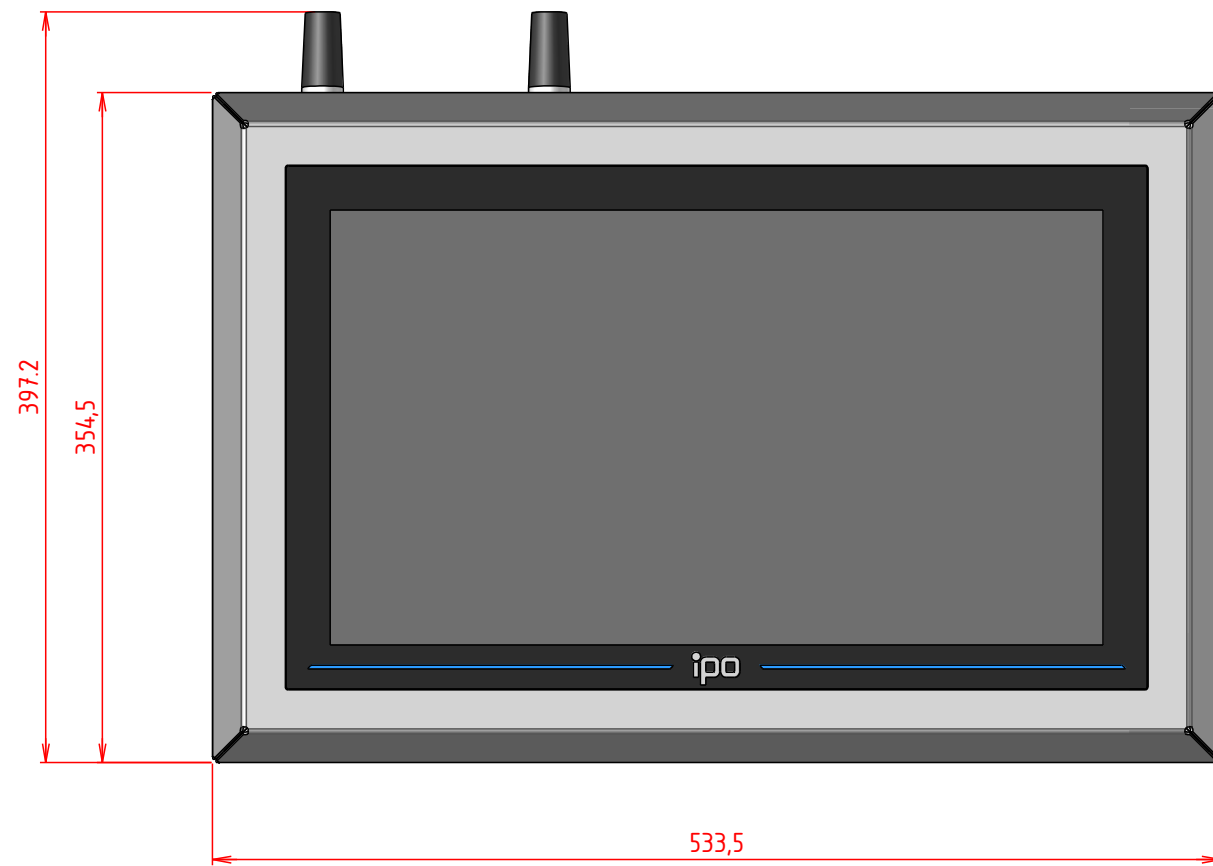

VUE ARRIERE

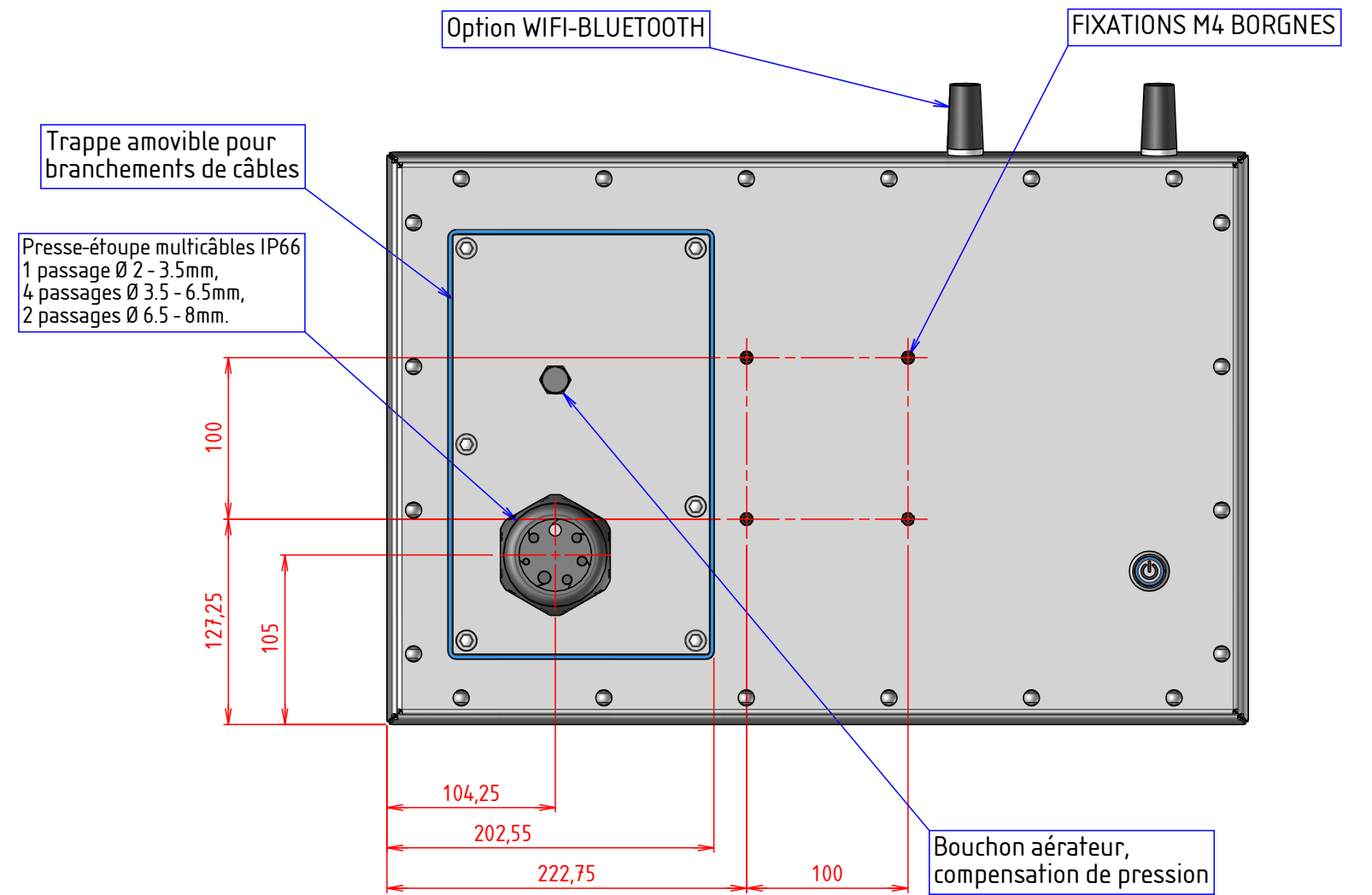

VUE DE DESSUS

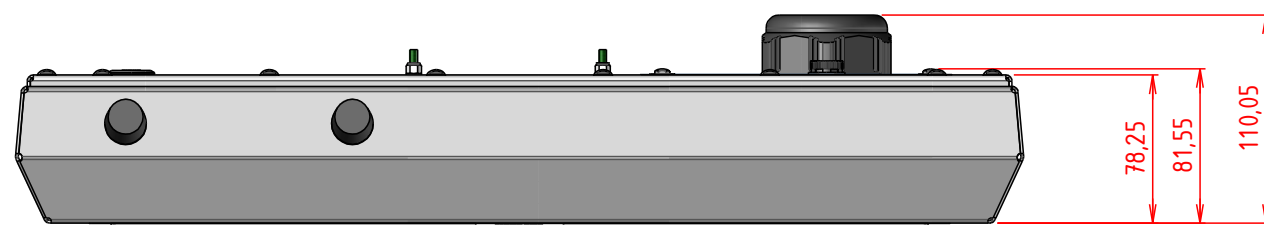

PERSPECTIVE

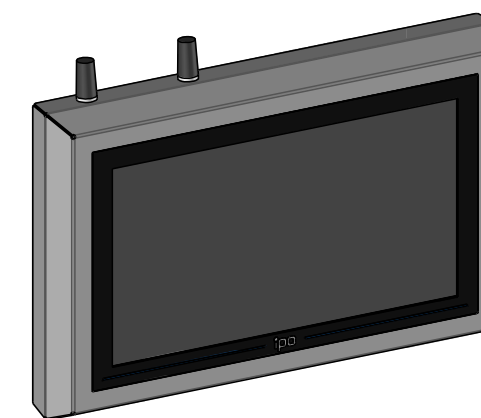

D

A