



- ▶ Industrial "All-In-One" - Standalone Panel PC
- ▶ Fanless solution
- ▶ True-flat front panel - Multitouch PCAP touch screen
- ▶ Protection IP65 & Impact resistant IK08 on front
- ▶ LED display 15.6" Wide 16:9 - Resolution HD 1366 x 768
- ▶ Available in different versions of Intel® processor
- ▶ Cable cover with retaining joint
- ▶ Internal power supply AC or DC type
- ▶ Standard warranty 5 years parts and labor back workshop

### Key points

- ▶ **Standalone** Panel PC
- ▶ **Option box** in the handle
- ▶ **IP65 & IK08** on front panel
- ▶ **Internal** power supply



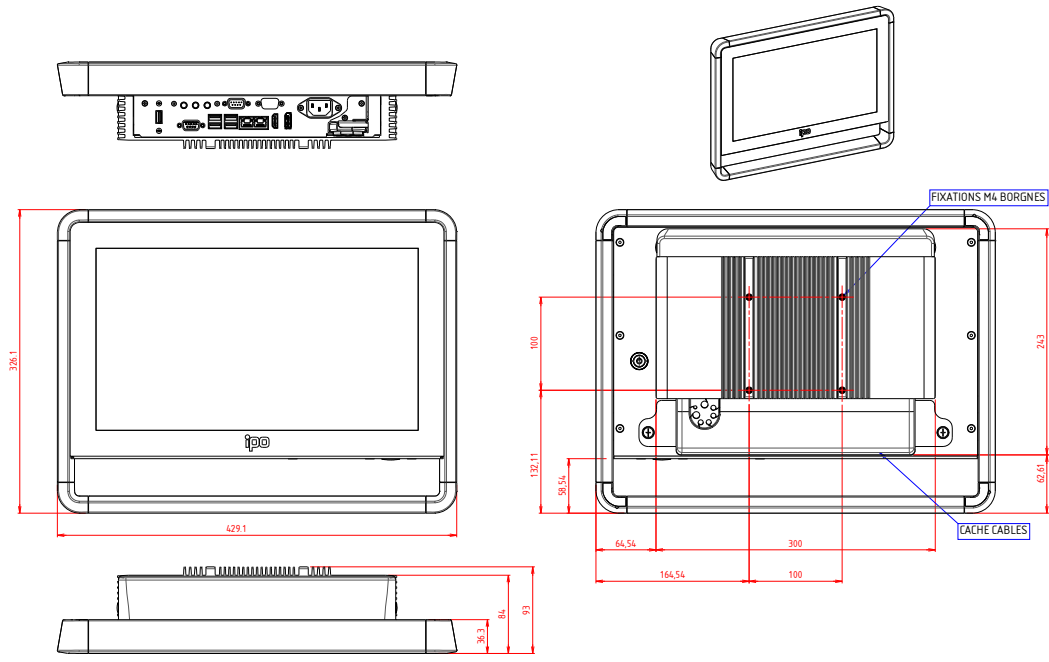







### Mechanical dimension













### Ordering Information

- FUTURA15WQPA-CV-\*\*** Industrial rugged Fanless True-flat Panel PC - Standalone with handle - IP65 & IK08 front panel - 15.6" HD - Intel® Pentium® QC N4200 - PCAP touch screen - Choose power supply
- FUTURA15WCIB-CV-\*\*** Industrial rugged Fanless True-flat Panel PC - Standalone with handle - IP65 & IK08 front panel - 15.6" HD - Intel® Core™ i5-7300U - PCAP touch screen - Choose power supply

\*\* : Choose your internal power supply type : AC 230VAC or DC 9-36VDC

		System		
	<b>Product name</b>	<b>FUTURA-15WQP</b>	<b>Product name</b>	<b>FUTURA-18WCI</b>
	<b>CPU Intel®</b>	Pentium® N4200 Quad Core (1.1/2.5GHz) – TPM (2.0)	<b>CPU Intel®</b>	Core™ i5-7300U (2.6/3.5GHz) – TPM (2.0)
	<b>Memory</b>	2 x DDR3L-1866 SO-DIMM (max. 8 Gb)	<b>Memory</b>	2 x DDR4-2133 SO-DIMM (max. 32Gb)
	<b>HDD / SSD</b>	1 x 2”1/2 SATA + 1 x mSATA + 1 x M.2 (B-key)	<b>HDD / SSD</b>	1 x 2”1/2 SATA + 1 x mSATA
	<b>Operating system</b>	Win 10 IoT Enterprise – Win 10 PRO – Win 11 PRO Linux on demand	<b>Operating system</b>	Win 10 IoT Enterprise – Win 10 PRO – Win 11 PRO Linux on demand
	<b>I/O Ports</b>	4 x USB 3.0 – 1 x USB 2.0 2 x RS232 2 x Gigabit Ethernet (RJ45) 1 x Display port – 1 x HDMI – 1 x Bloc audio	<b>I/O Ports</b>	4 x USB 3.0 – 1 x USB 2.0 2 x RS232 2 x Gigabit Ethernet (RJ45) 1 x Display port – 1 x HDMI – 1 x Bloc audio
	<b>Construction Material</b>			<b>Display</b>
	<b>Chassis</b>	Treated aluminum case – 2mm thick	<b>Size/Type</b>	15.6” Wide – LED
	<b>Frame</b>	Anodized aluminum profile – 1.5mm thick	<b>Display area</b>	344 x 193 mm
	<b>Coin</b>	Polycarbonate – black standard – customizable	<b>Resolution max.</b>	1366 x 768 HD
	<b>Front panel</b>	Trueflat + Front touch panel – 2.8mm thick	<b>LCD Color</b>	16.7 millions
	<b>Color</b>	RAL9005 black textured paint rear chassis	<b>Pixel Pitch</b>	0.252 mm
	<b>Mounting</b>	VESA 100 integrated into the heatsink	<b>Brightness</b>	500 cd/m²
	<b>I/O cover</b>	With passage joint – cable retention	<b>Contrast Ratio</b>	500:1
	<b>Speaker</b>	1 x 3W	<b>Viewing Angle max.</b>	Horizontal : 170° – Vertical : 160°
	<b>Protection</b>			<b>Touch screen</b>
	<b>IP level</b>	IP65 compliant front panel	<b>Technology</b>	10-point Projected capacitive touch window
	<b>Shock</b>	Impact resistance IK08	<b>Résistance</b>	6H
	<b>Button &amp; Indicator</b>			<b>Industrial power supply</b>
	<b>Rear panel</b>	On/Off switch button with LED backlight Brightness adjustment by software application (for Windows)	<b>Version AC~</b>	Input: 115/230VAC – Frequency: 50/60Hz
			<b>Version DC</b>	Wide range: 9–36VDC Reverse polarity protection – Galvanic isolation
			<b>Power Consumption max</b>	Version QP: 85W – Version CI: 100W
	<b>Environment</b>			<b>Safety and EMC</b>
	<b>Operating Temperature</b>	0° ~ + 45°C	<b>Safety</b>	EN 62368-1
	<b>Storage Temperature</b>	- 20 .... + 60°C	<b>EMC</b>	EN 55032 / EN 55024 EN 61000-3-2 / EN 61000-3-3
	<b>Relative Humidity</b>	5 ..... 95 %		<b>Dimensions</b>
	<b>Cooling system</b>		<b>Dimensions ((WxLxD)</b>	429.1 x 326.1 x 93 mm
	<b>Type</b>	Fanless Natural convection cooling	<b>Weight (Net) – kg</b>	5.5

## Options & Accessories

	<b>ZFUT-PT</b>	VESA table stand		<b>ZFUT-SUP-CLAV</b>	Keyboard Support
	<b>ZFUT-BT</b>	Arm mounting table solution		<b>FUT-SUP-DOUCH</b>	Bar code reader support
	<b>ZFUT-BM</b>	Arm mounting wall solution		<b>ZFUT-ARGOS</b>	Adjustable desk support
	<b>PIED-TUBE-L1400</b>	Floor Tube Foot Support – Square format – Height: 1400mm		<b>ZFUT-WIFI-A</b>	Solution Wifi + Bluetooth
	<b>Option box:</b> in the frame under the machine Output on front or rear face – different sizes allowing custom integration: RFID reader, Emergency stop, Function keys, USB, RS-232, Lan, ...				

## Packing list

1 x Power cord CE22 1.80 m (AC~ version)

1 x Software Licence (label format)

1 x Production&Traceability datasheet